

1. FULLY ASSEMBLED BASE MACHINE WITHOUT EQUIPMENT. APPROX WEIGHT - 147155 kg
 INCLUDES COMPLETE EXTENDING LOWER STRUCTURE, MODIFIED UPPER STRUCTURE, MODIFIED OEM COUNTERWEIGHT, CAB GUARD, DUST SUPPRESSION TANKS, WALKWAYS, BELLY PLATES, FLUIDS (FUEL/OIL ETC).
 SEE LIEBHERR R984C BROCHURE FOR DATA SPECIFIC TO UNMODIFIED ELEMENTS OF BASE MACHINE.

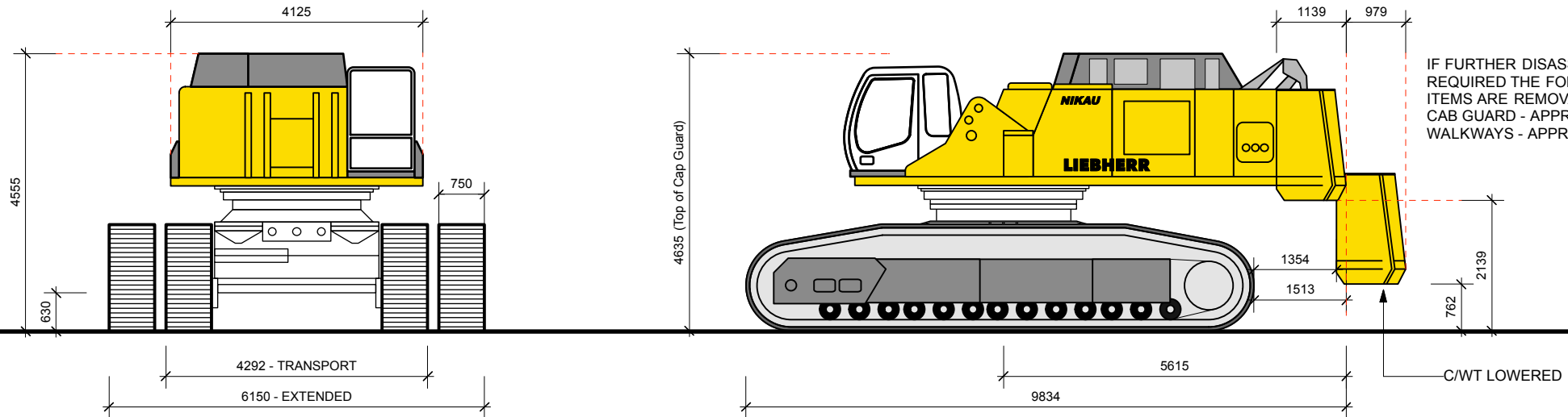

IF FURTHER DISASSEMBLY IS
 REQUIRED THE FOLLOWING
 ITEMS ARE REMOVABLE:
 CAB GUARD - APPROX 900 kg
 WALKWAYS - APPROX 550 kg

2. UPPER STRUCTURE. (CWT REMOVED)
 APPROX WEIGHT - 49208 kg

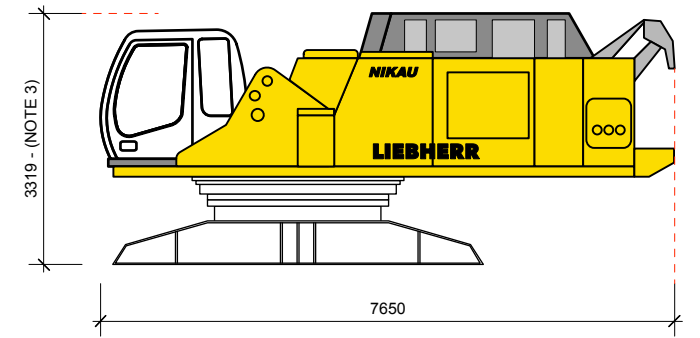

3. EXTENDING LOWER STRUCTURE.
 APPROX WEIGHT - 69897 kg
 (APPROX WEIGHT TRACKS - 6600 kg EACH)

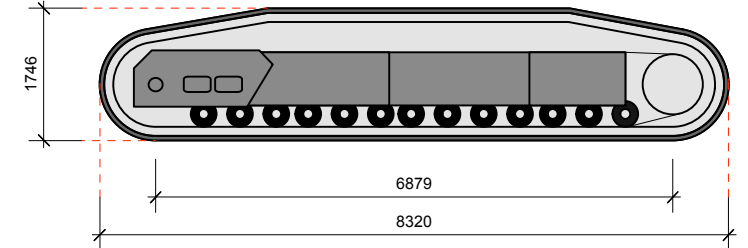

5. 6m DIPPER ON CRADLE. APPROX WEIGHT - 3483 kg
 INCLUDES DIPPER, ATTACHMENT CYLINDER + GUARD, LINKAGE, CRADLE

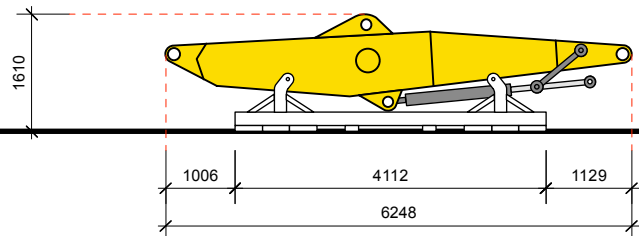

6. 10.5m DIPPER ON CRADLE. APPROX WEIGHT - 3843 kg
 INCLUDES DIPPER, ATTACHMENT CYLINDER + GUARD, LINKAGE, CRADLE

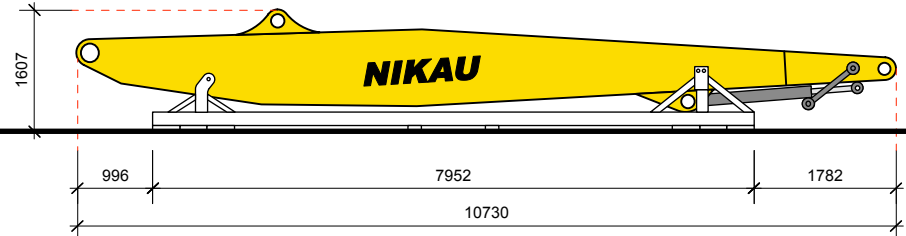

4. MODIFIED OEM C/W.
 APPROX WEIGHT - 28050 kg

TRAILER - LOWLOADER
 NOOTBOOM 87-14

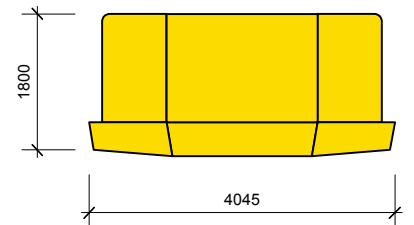

7. TELESCOPIC DEMOLITION RIG ON TRAILER. APPROX WEIGHT - 62282 kg
 INCLUDES HYDRAULIC CRADLES, HOIST CYLINDERS TELEBOOM, MID DIPPER, 10.5m DIPPER, DEMO CYLINDERS, ATTACHMENT CYLINDER + GUARD, LINKAGE

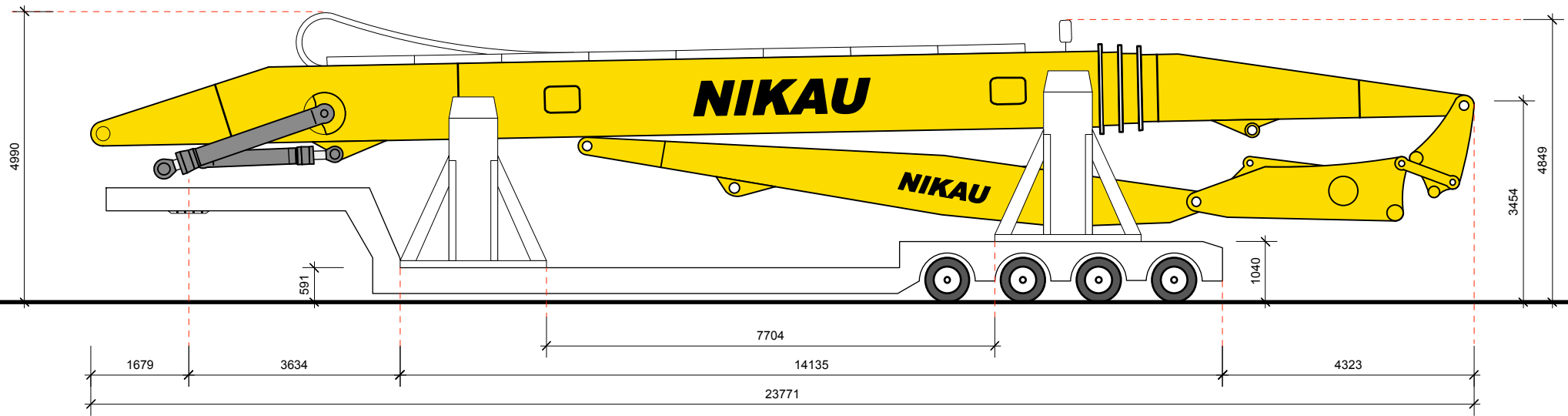

8. GOOSNECK BOOM. APPROX WEIGHT - 13345 kg
 INCLUDES STICK CYLINDER

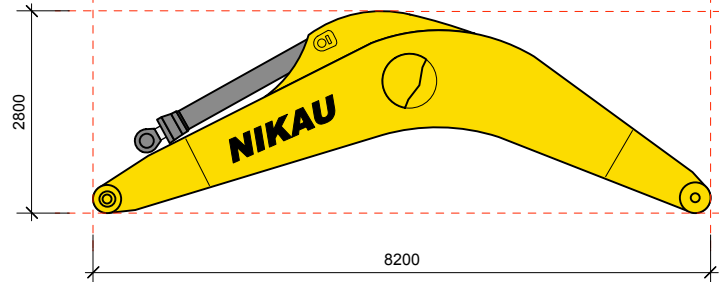

9. STICK. APPROX WEIGHT - 7400 kg
 INCLUDES BUCKET CYLINDER

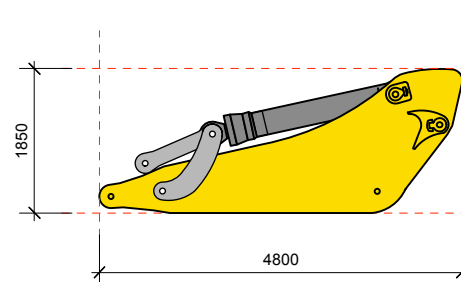

10. BACKHOE BUCKET (HD) - 7700 kg
 CAPACITY 7.70 M3

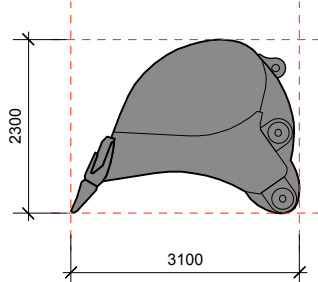

11. CRUSHER - 2500 kg
 NPK: S-24XC(R)

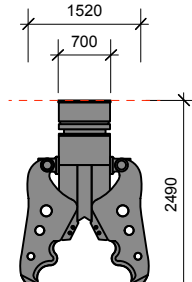

12. CRUSHER - 3500 kg
 NPK: S-36XC(R)

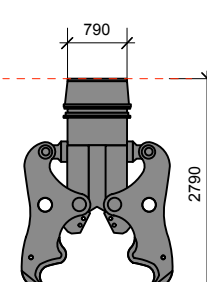

13. CRUSHER - 14000 kg
 MULTISYSTEM MS130

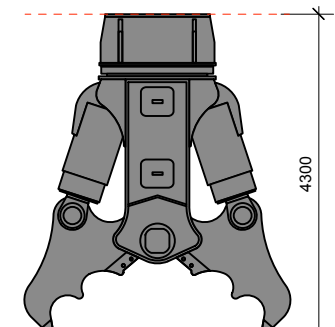

NOTES
 1. ALL DIMENSIONS AND WEIGHTS APPROXIMATE - ALL WEIGHTS STATED EXCLUDING ATTACHMENT
 2. SEE RELEVANT EQUIPMENT ASSEMBLIES FOR TRANSPORT DETAILS OF EQUIPMENT NOT SHOWN

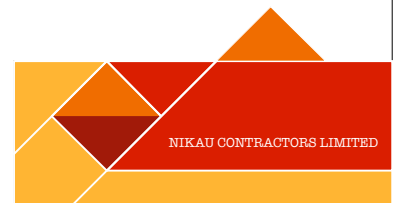

LIEBHERR
R984C
 BREAKDOWN WEIGHTS

Client
IN HOUSE

NikauGroup
 STRATEGIC DECONSTRUCTION & ENVIRONMENTAL

355 Church Street, Penrose, Auckland
 PO Box 13-761, Onehunga, Auckland
 Ph: (09) 636 5917 Fax: (09) 636 5918 Web: www.nikau.org

Plot Date : 23/04/2014
 Scale : 1:100 @ A3
 Drawn : R Bennett
 Rev. :

Sheet
LH-01